

Edelbrock



2nd Edition
With even more
fun activities!

MADE IN USA

Edelbrock

70

YEARS OF
PERFORMANCE

2008

Jr. Fun Team Coloring Book

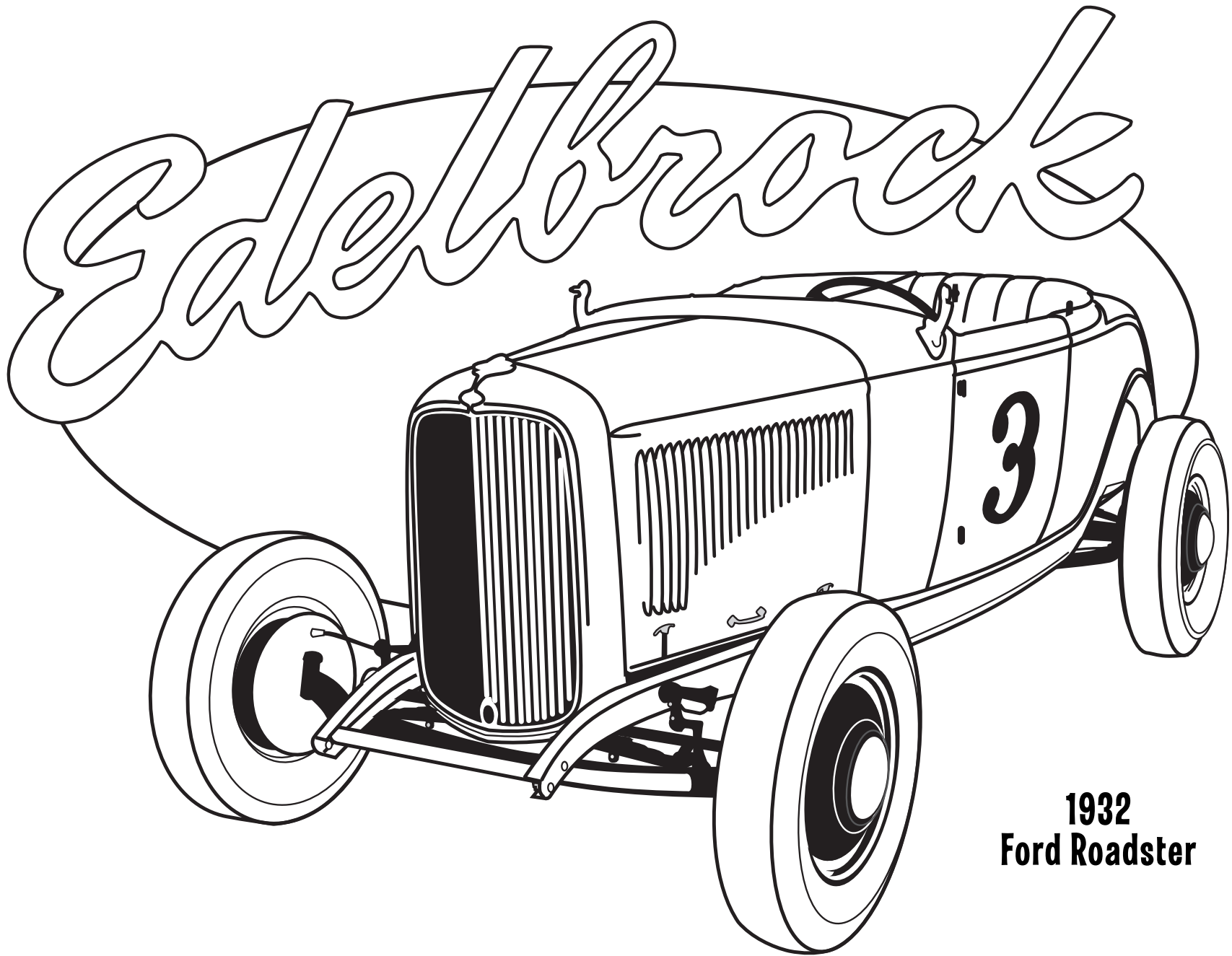

**1932
Ford Roadster**

Edelbrock

EQUIPPED

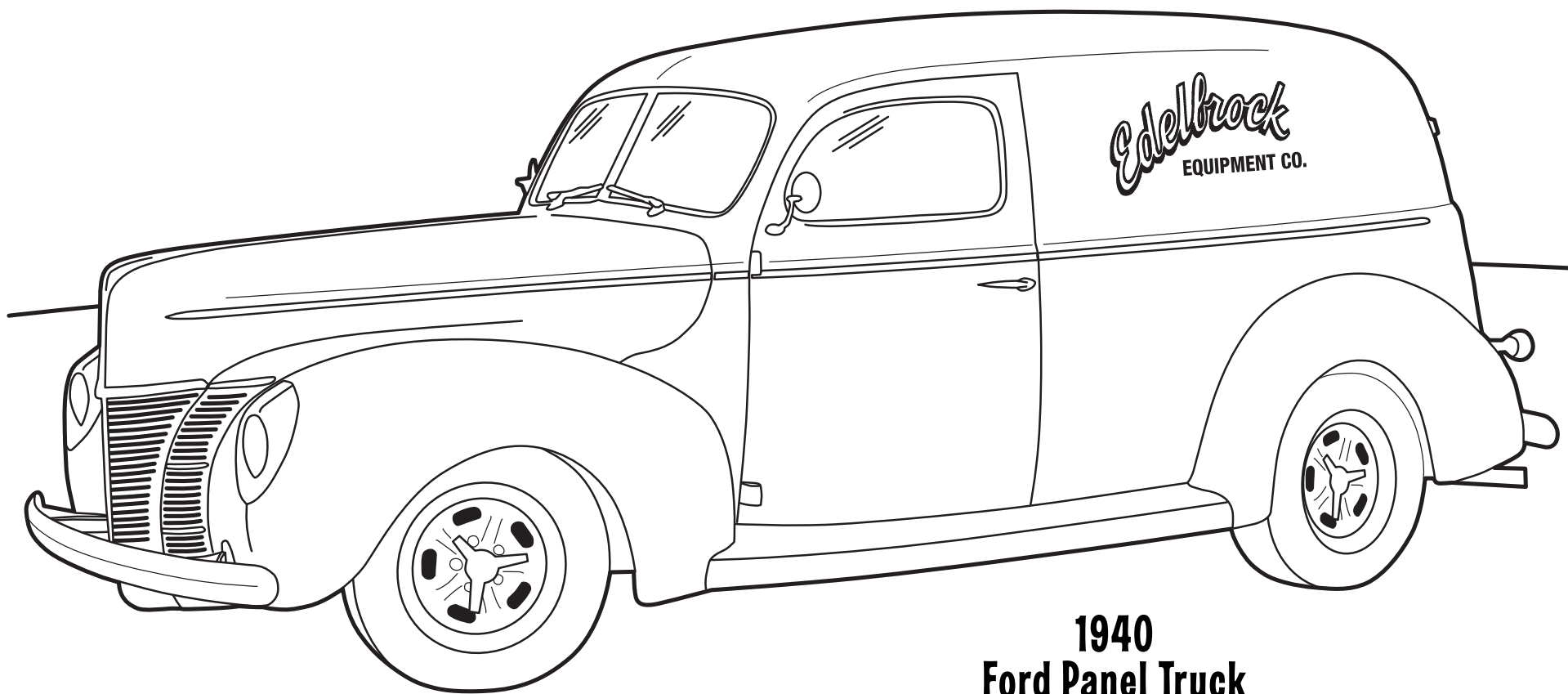

**1940
Ford Panel Truck**

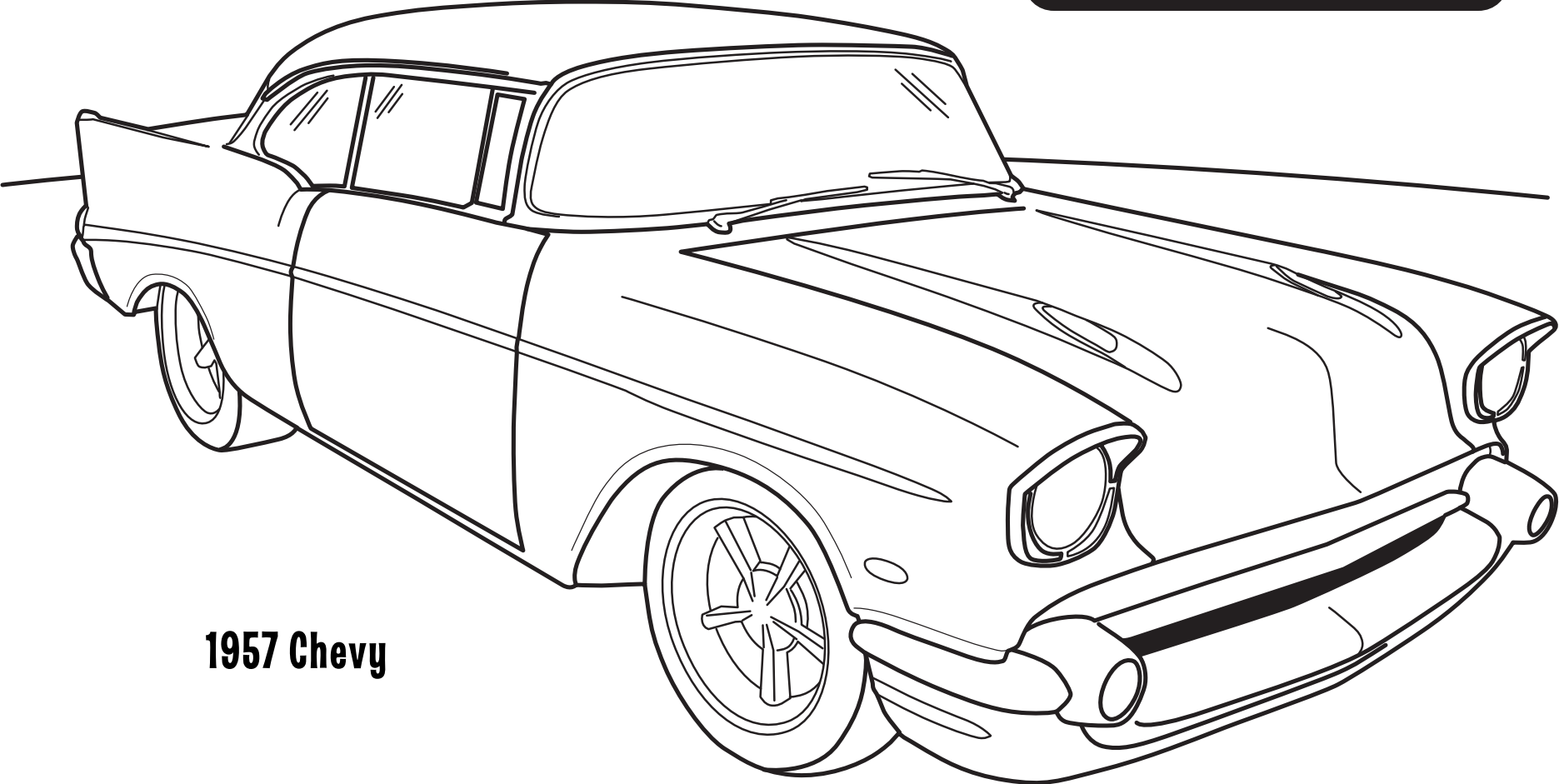

1957 Chevy

**Edelbrock[®]
Racing**

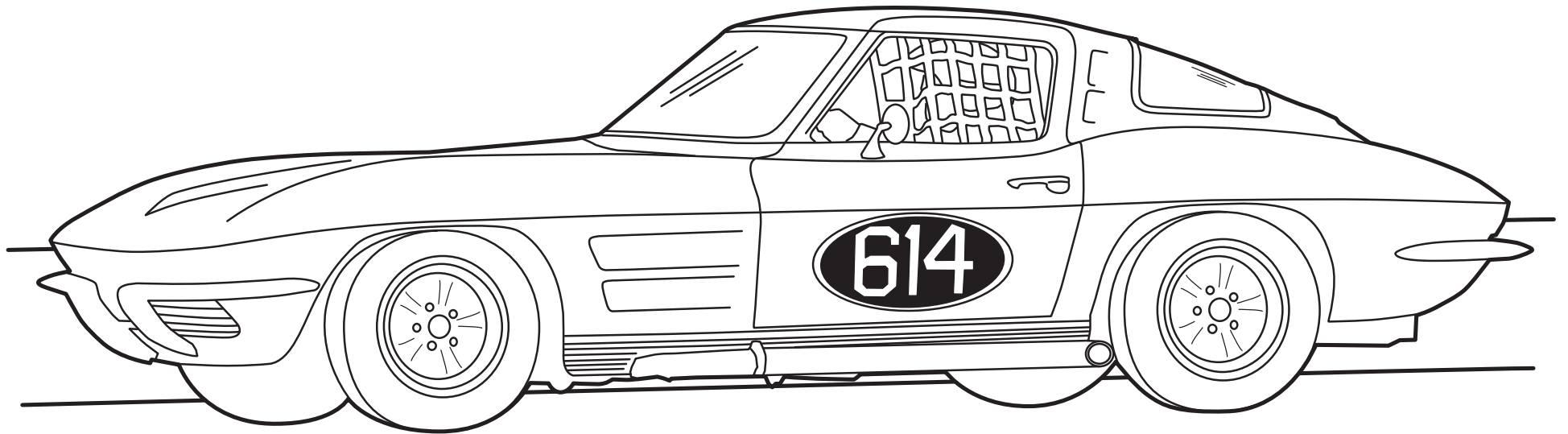

**1963 Split Window
Corvette**

Edelbrock[®]

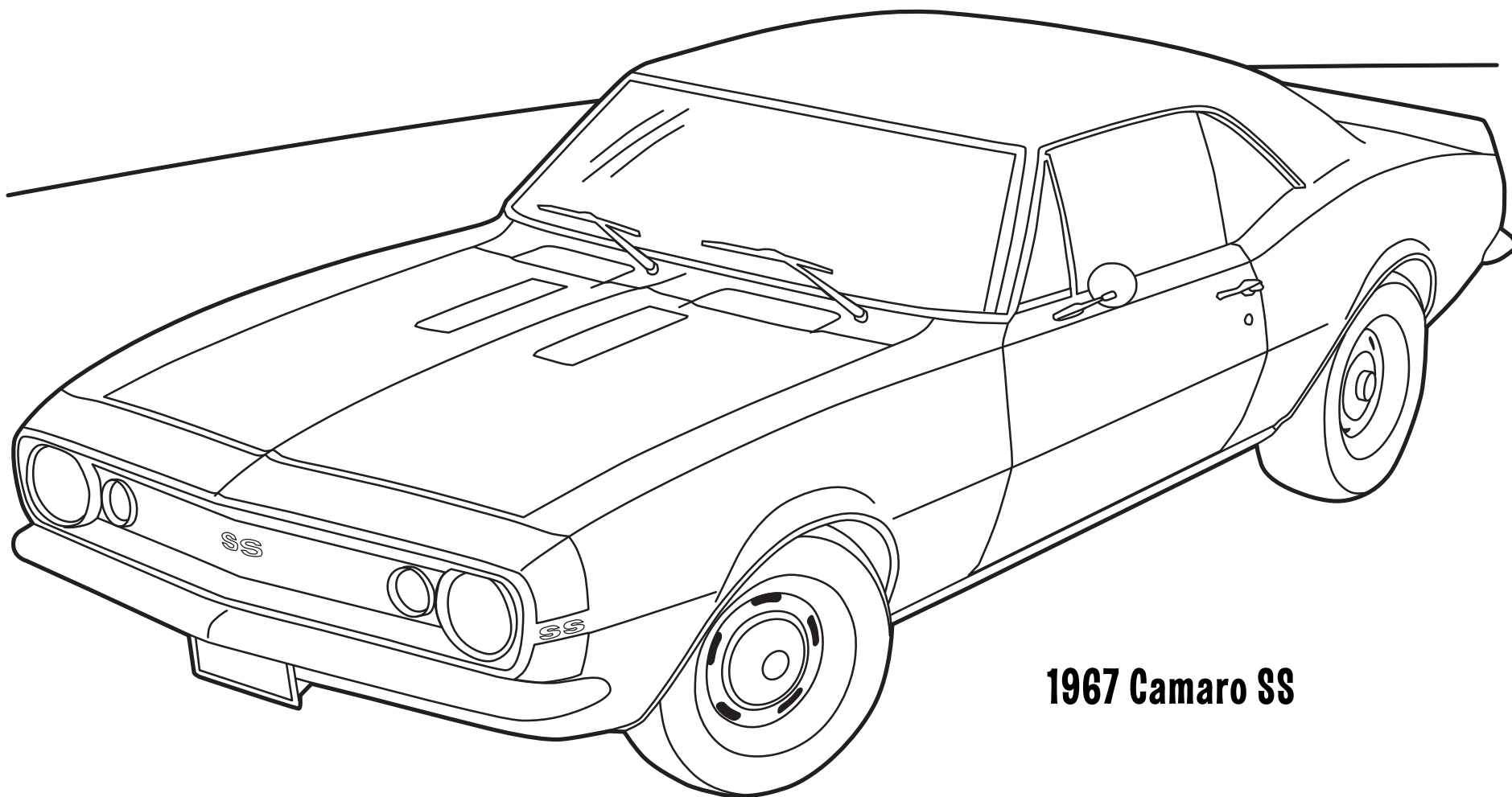

1967 Camaro SS

*Edelbrock[®]
Racing*

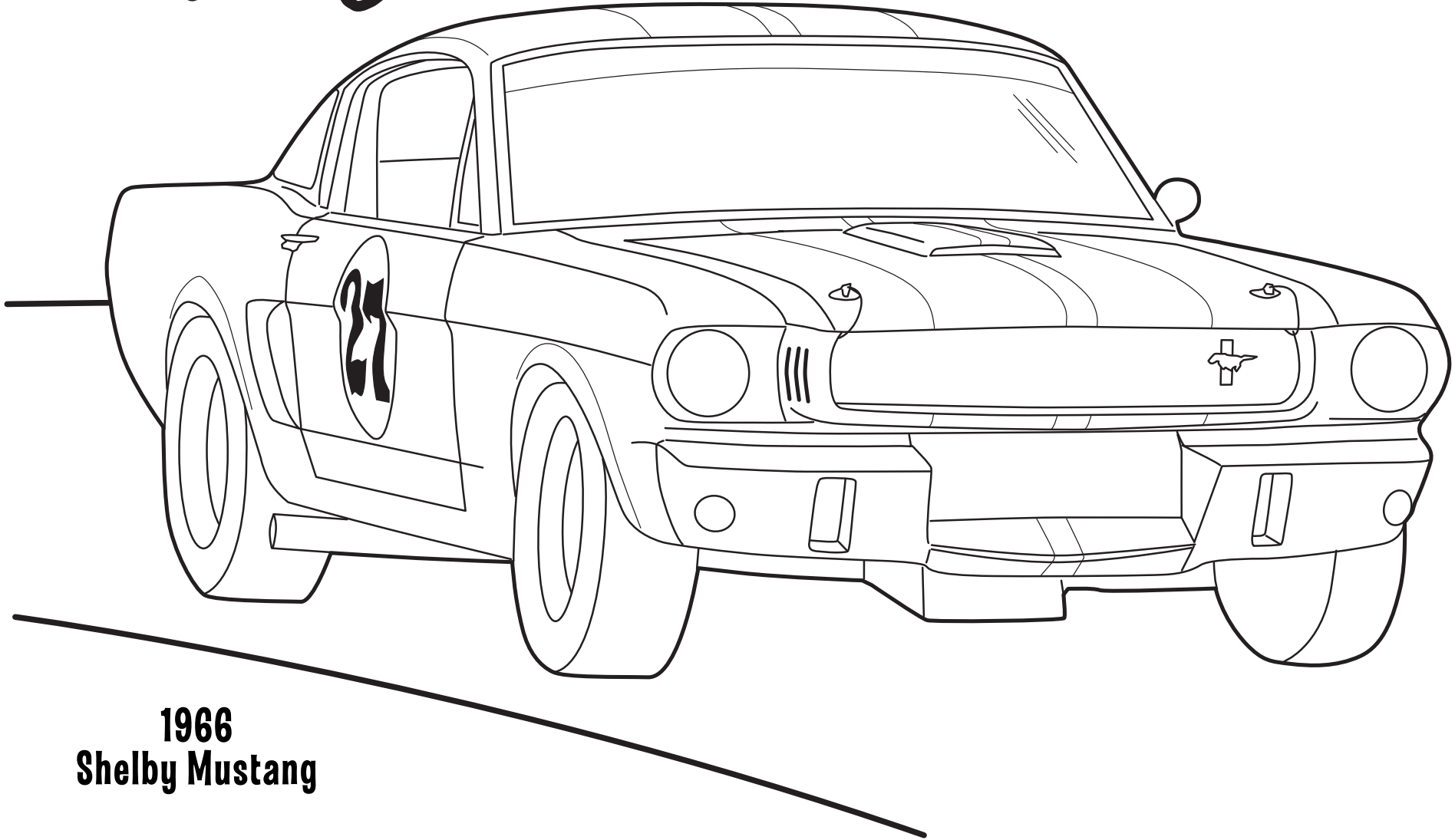

**1966
Shelby Mustang**

Edelbrock[®]

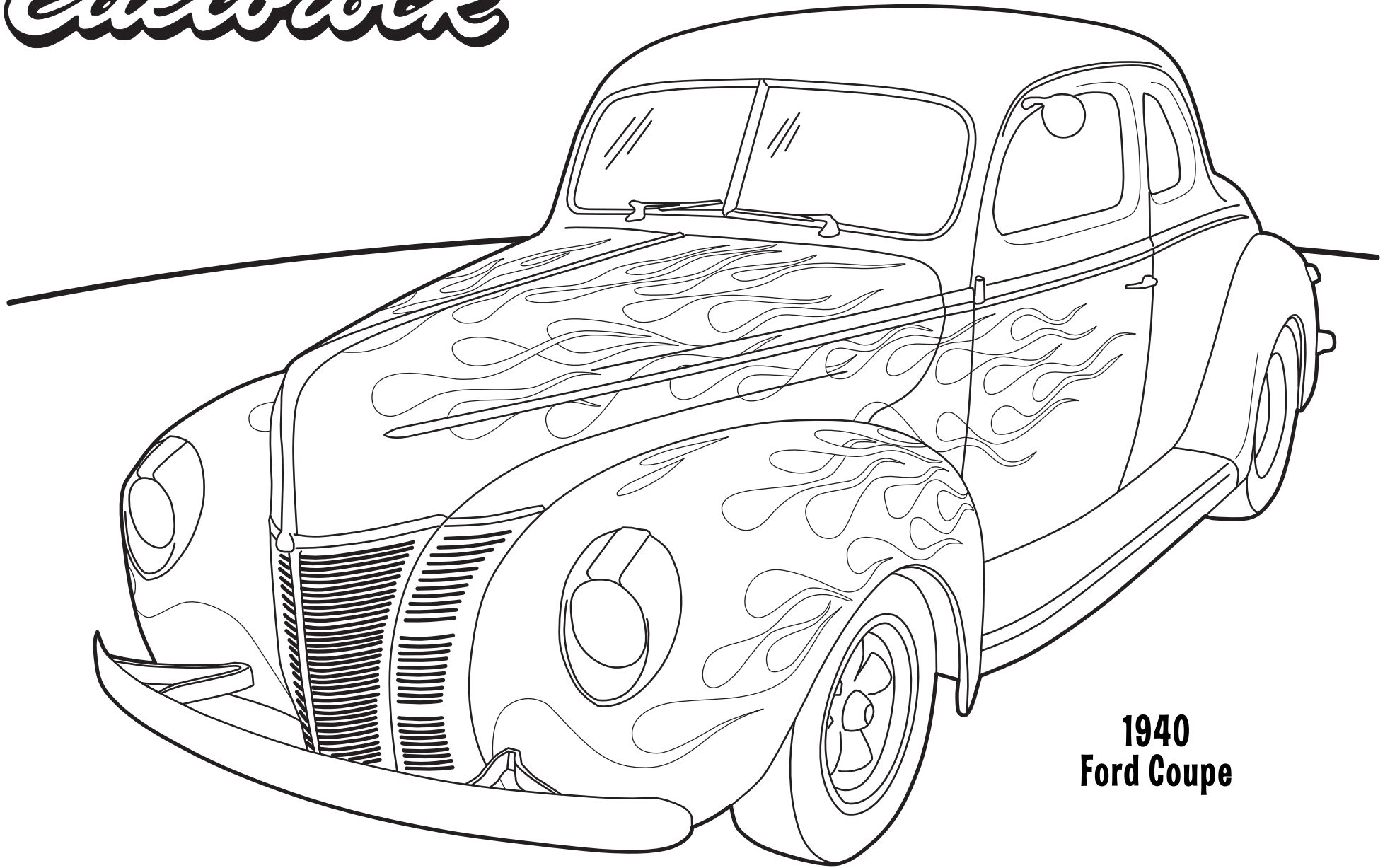

**1940
Ford Coupe**

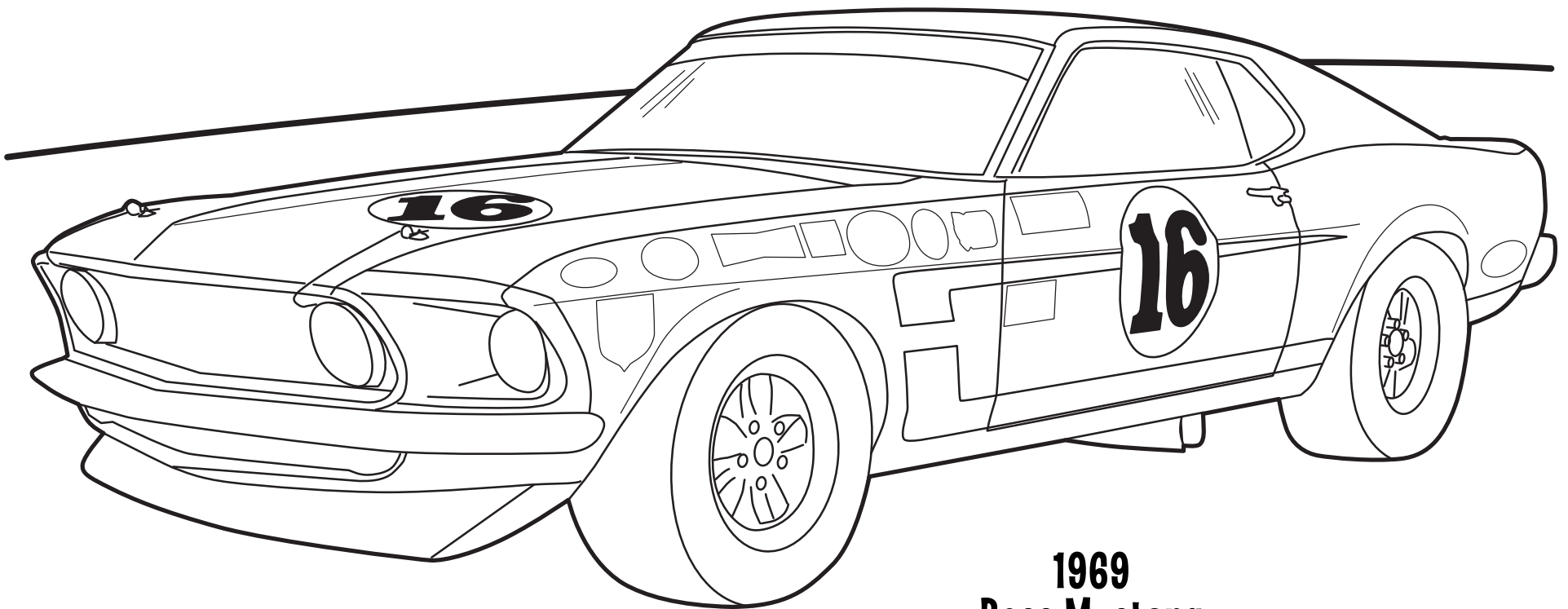

**1969
Boss Mustang**

**Edelbrock[®]
Racing**

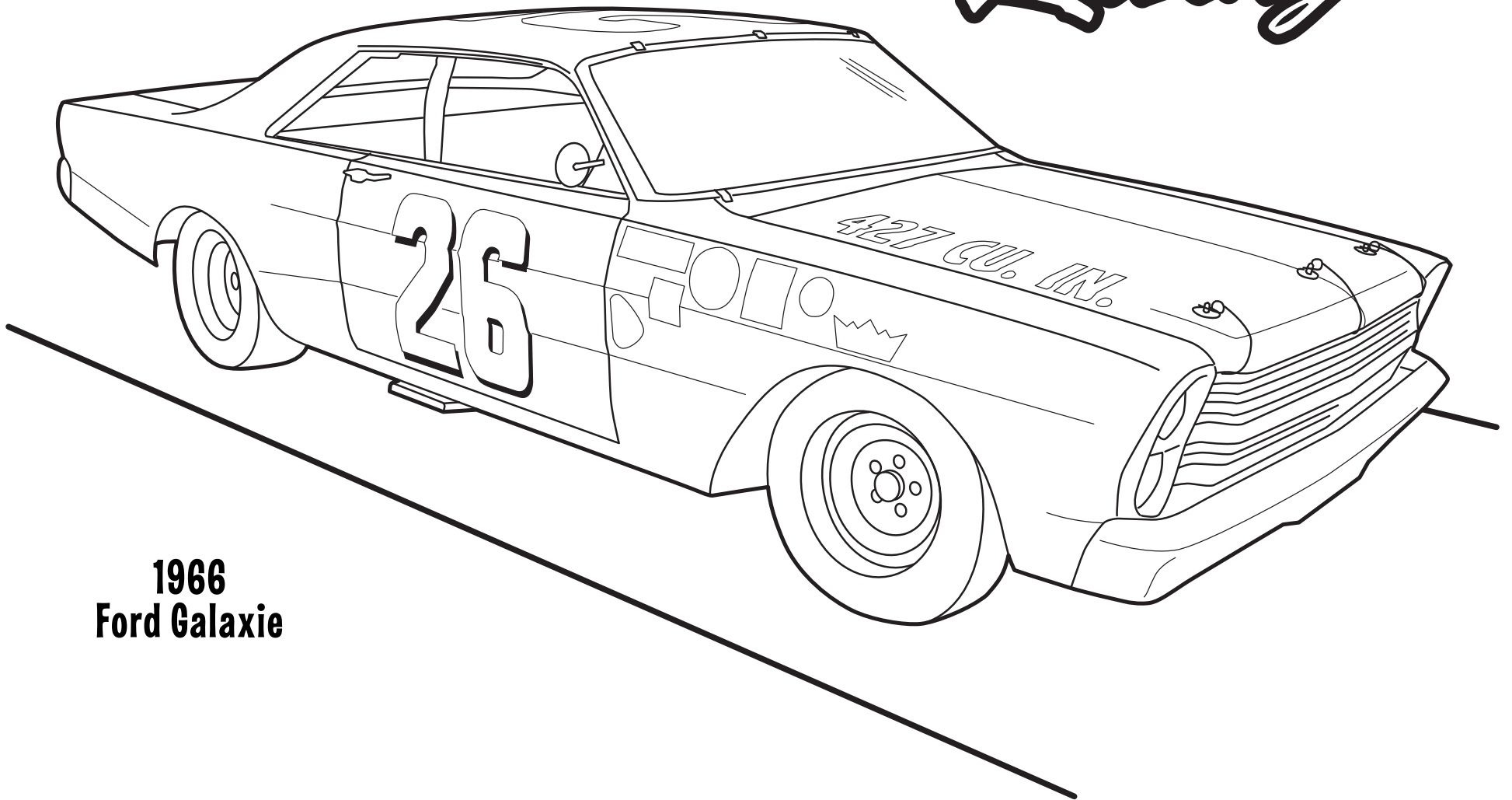

**1966
Ford Galaxie**

Edelbrock

**POWER & SPEED
EQUIPMENT**

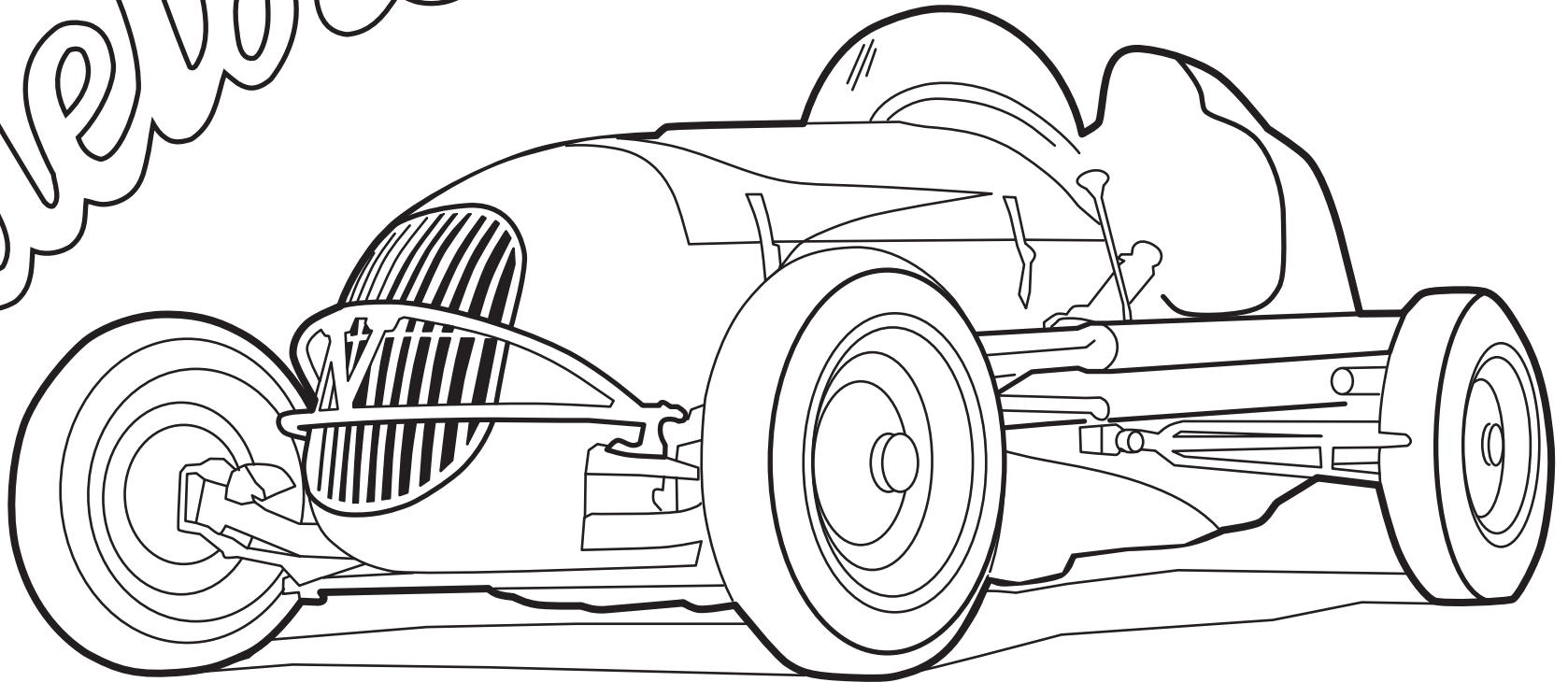

**1947
Kurtis-Kraft Midget**

Edelbrock

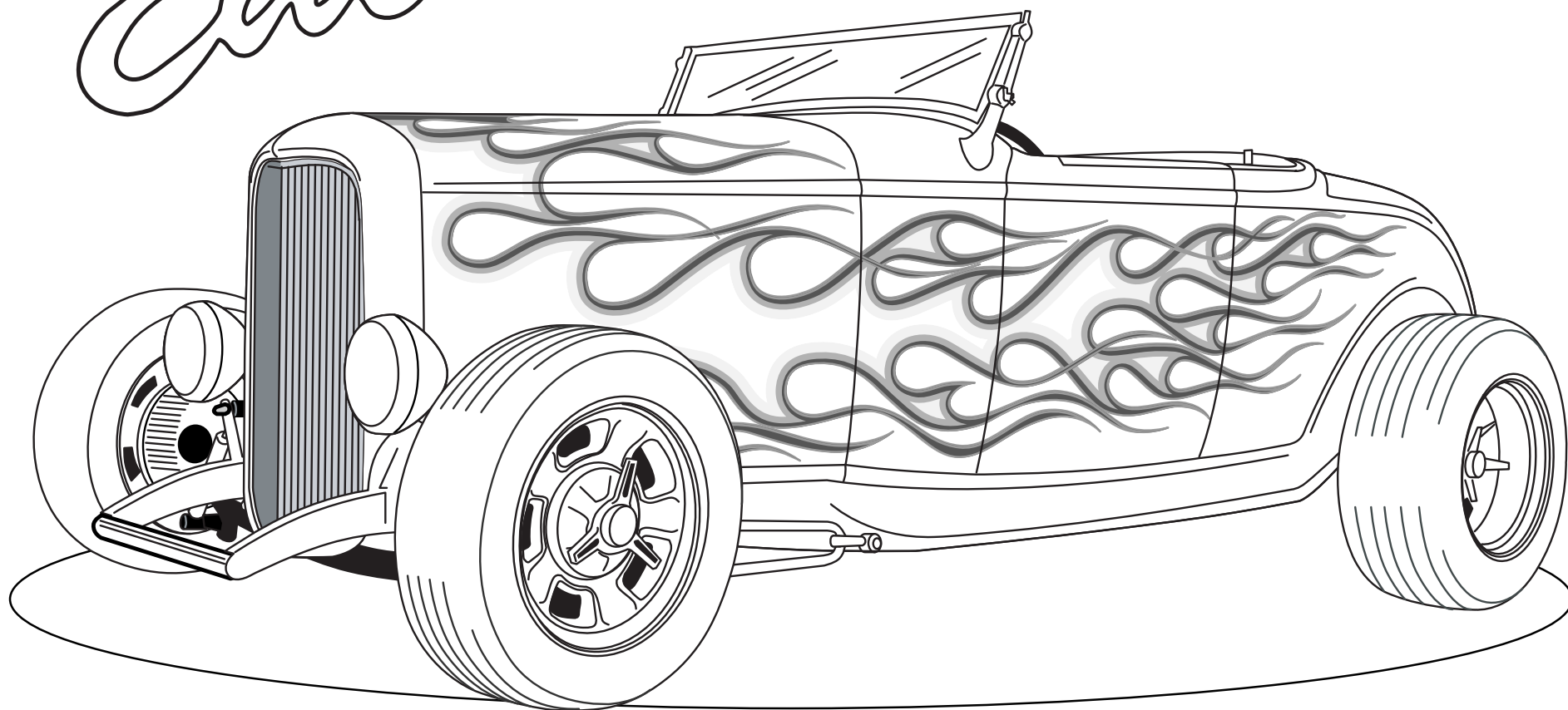

**1932
Ford Roadster**

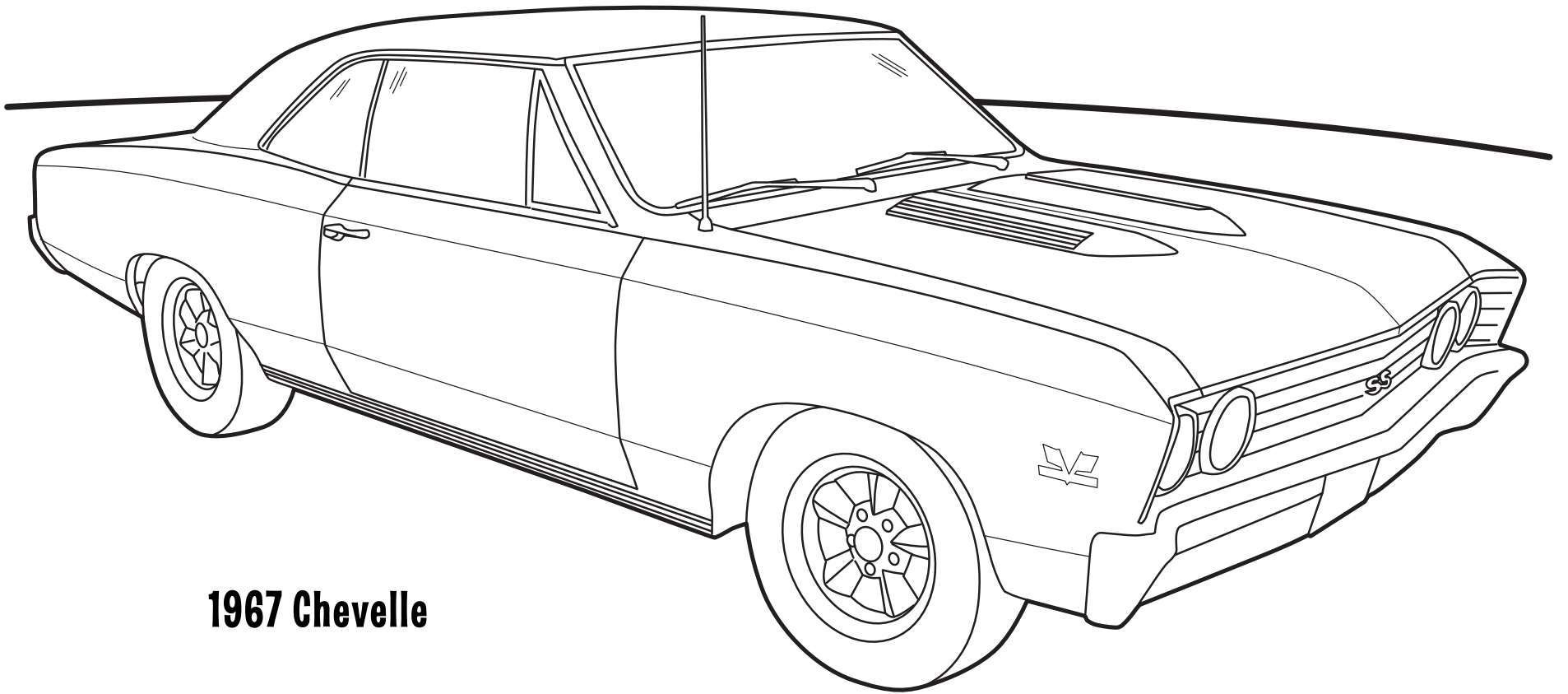

1967 Chevelle

**Edelbrock[®]
Racing**

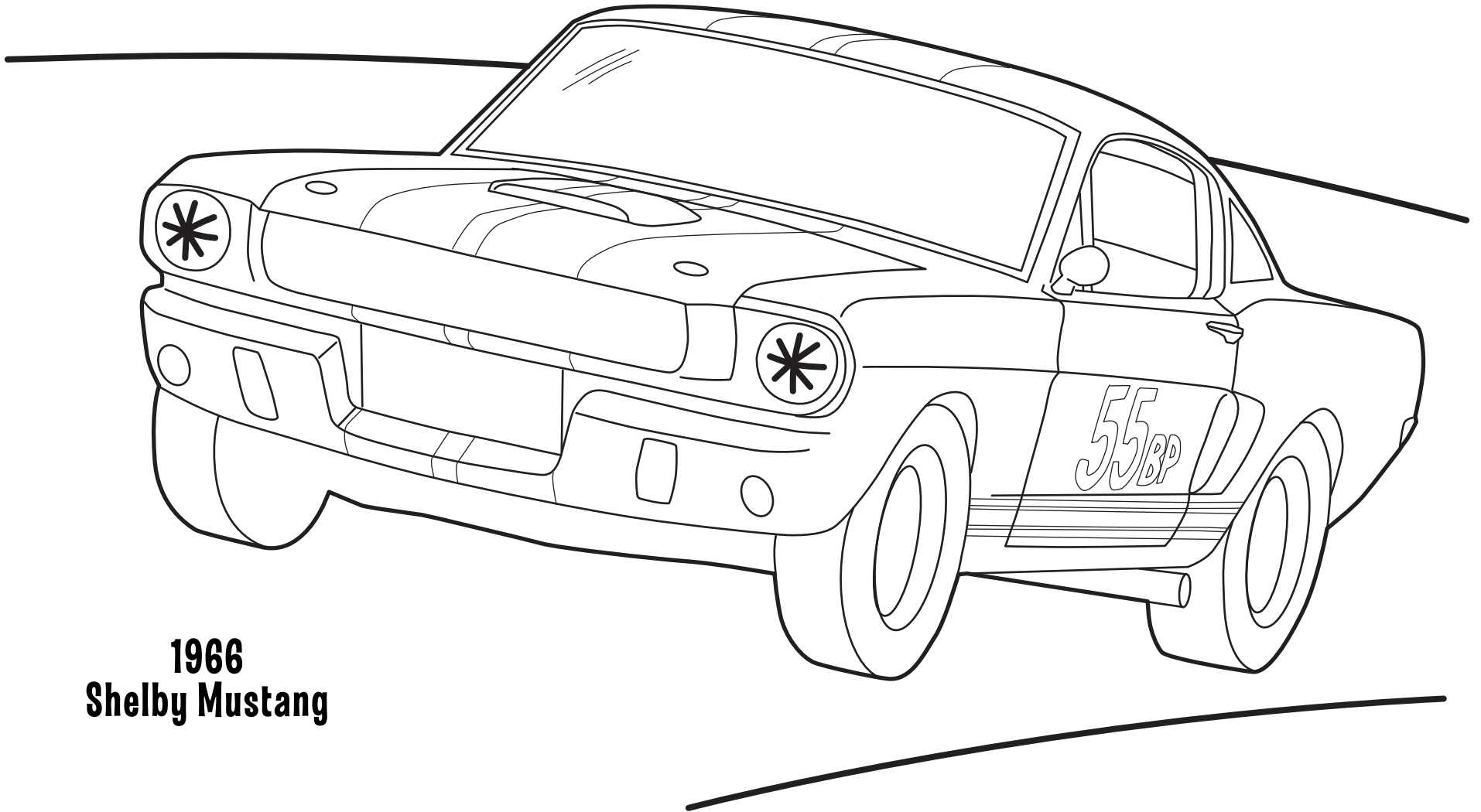

**1966
Shelby Mustang**

Edelbrock[®]

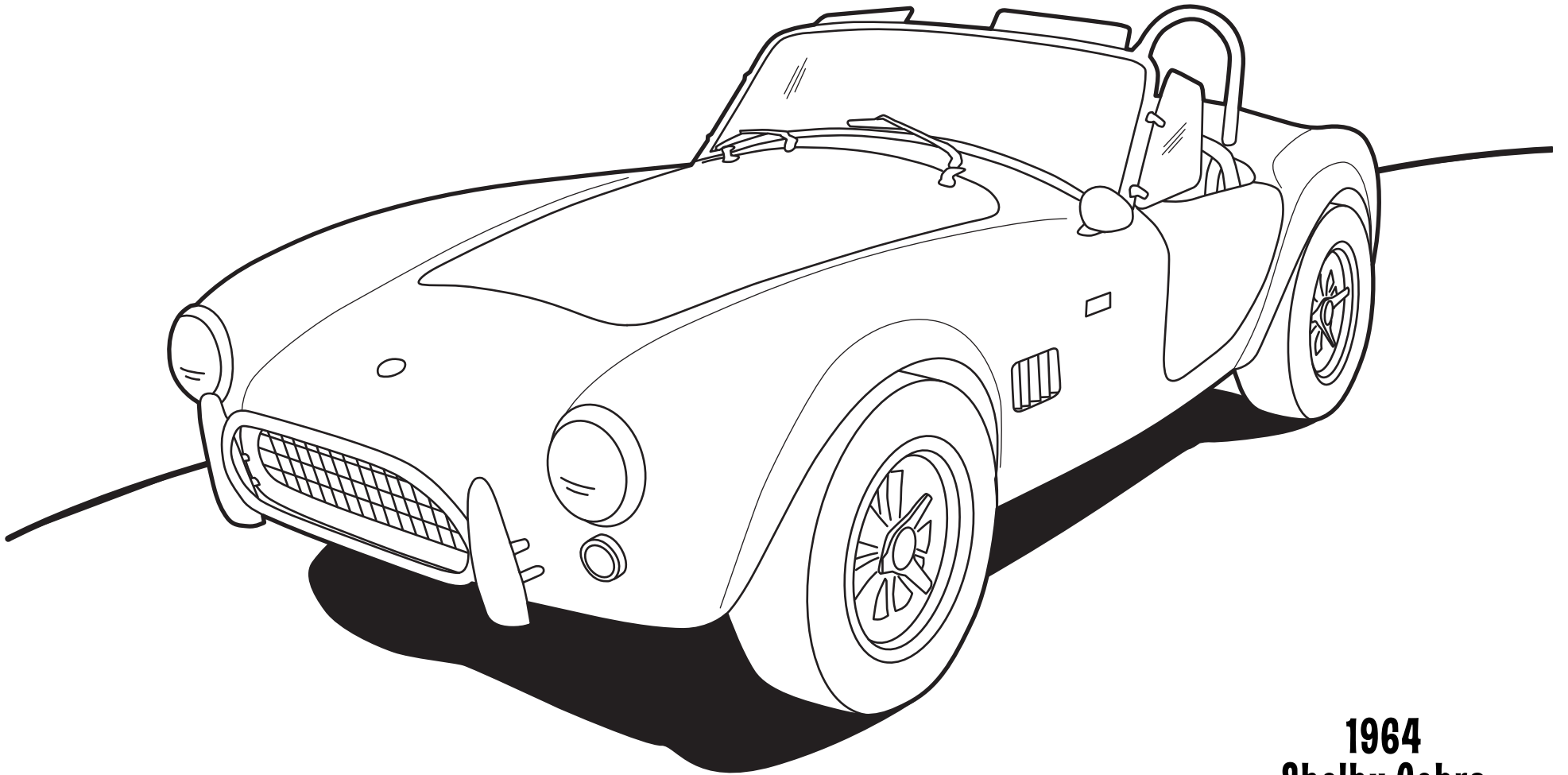

**1964
Shelby Cobra**

Edelbrock[®]

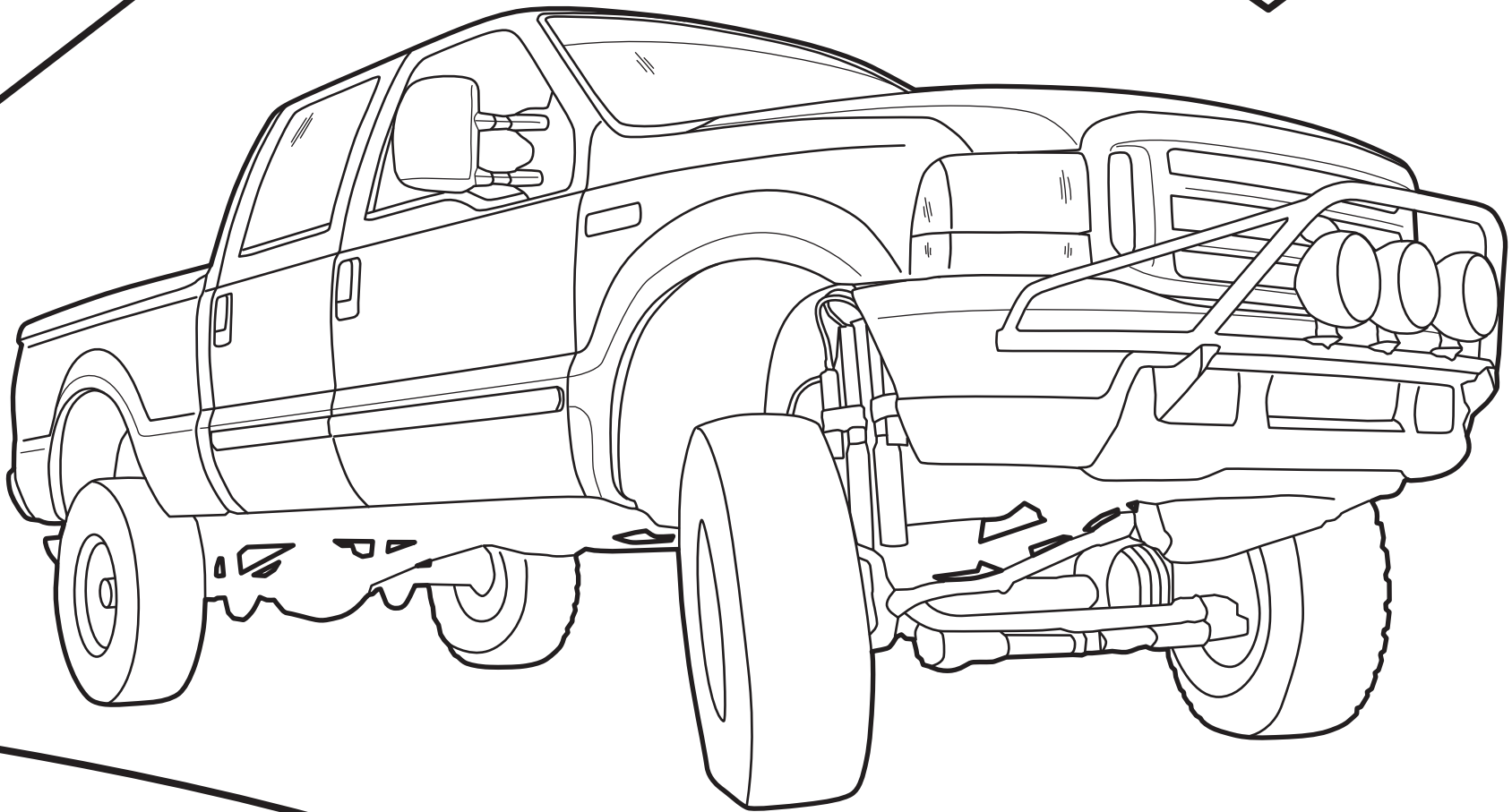

**2006
Ford F-250**

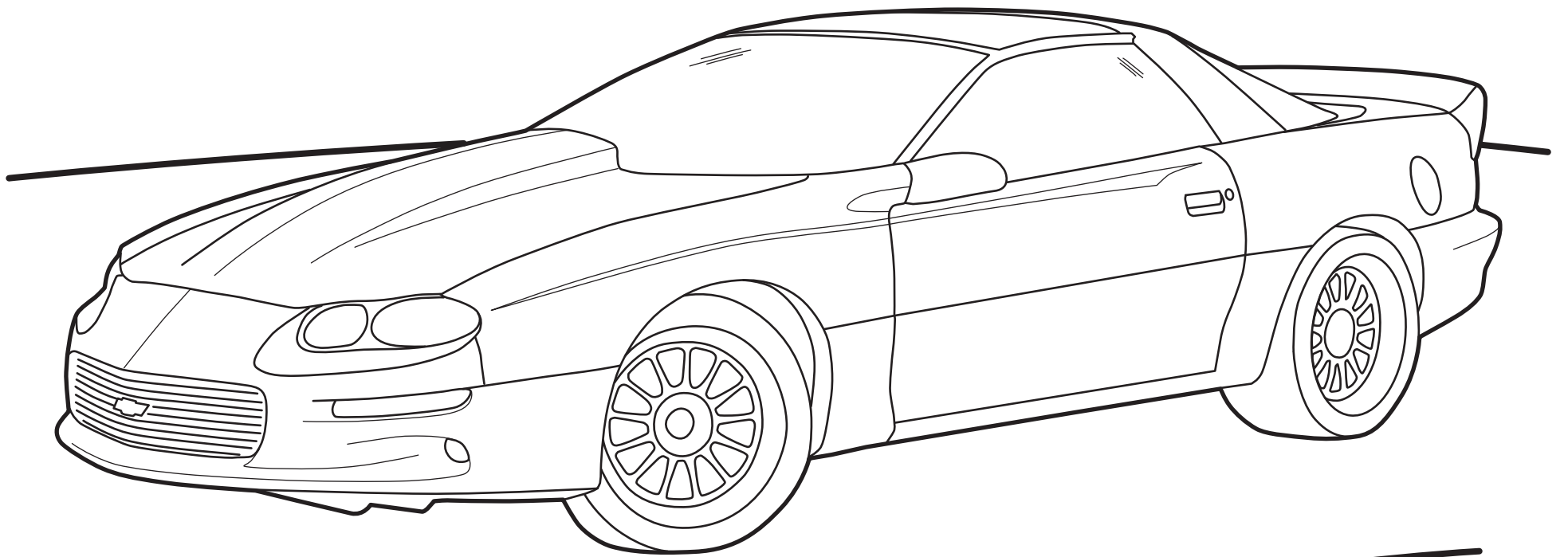

**2002
Dick Harrell Camaro**

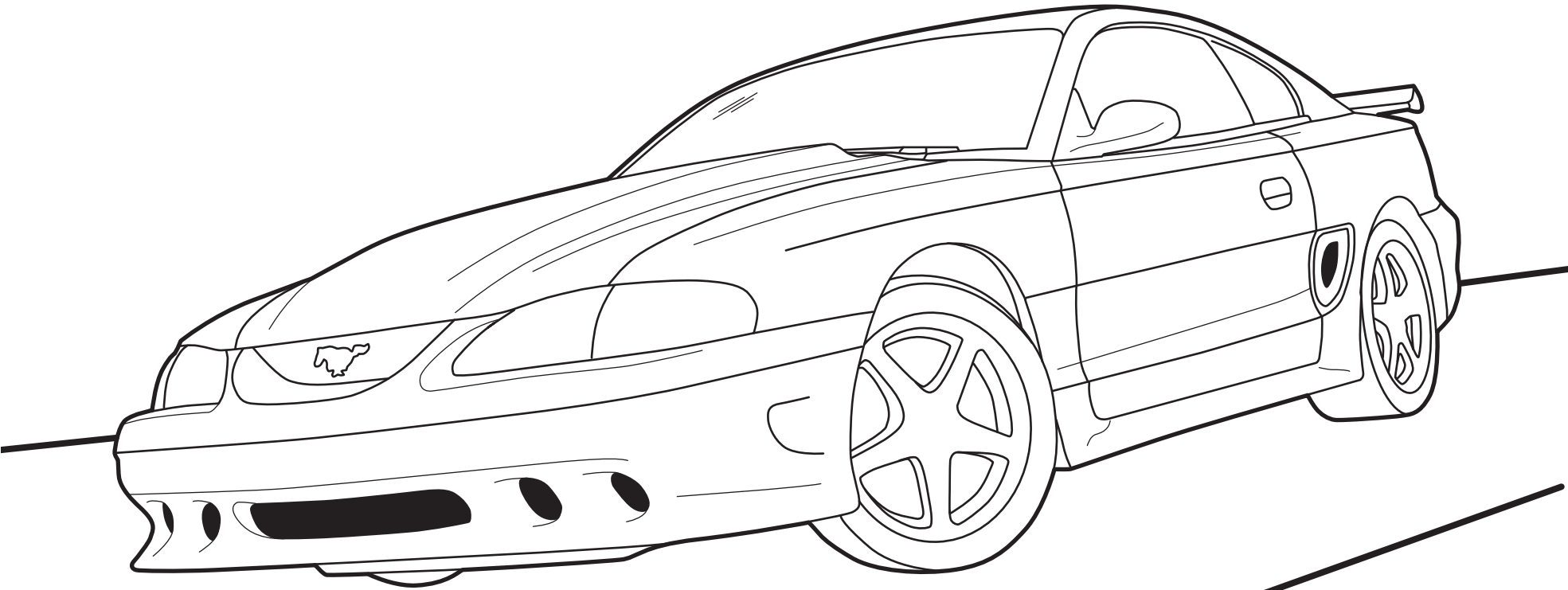

**1994
Ford Mustang**

Edelbrock[®]

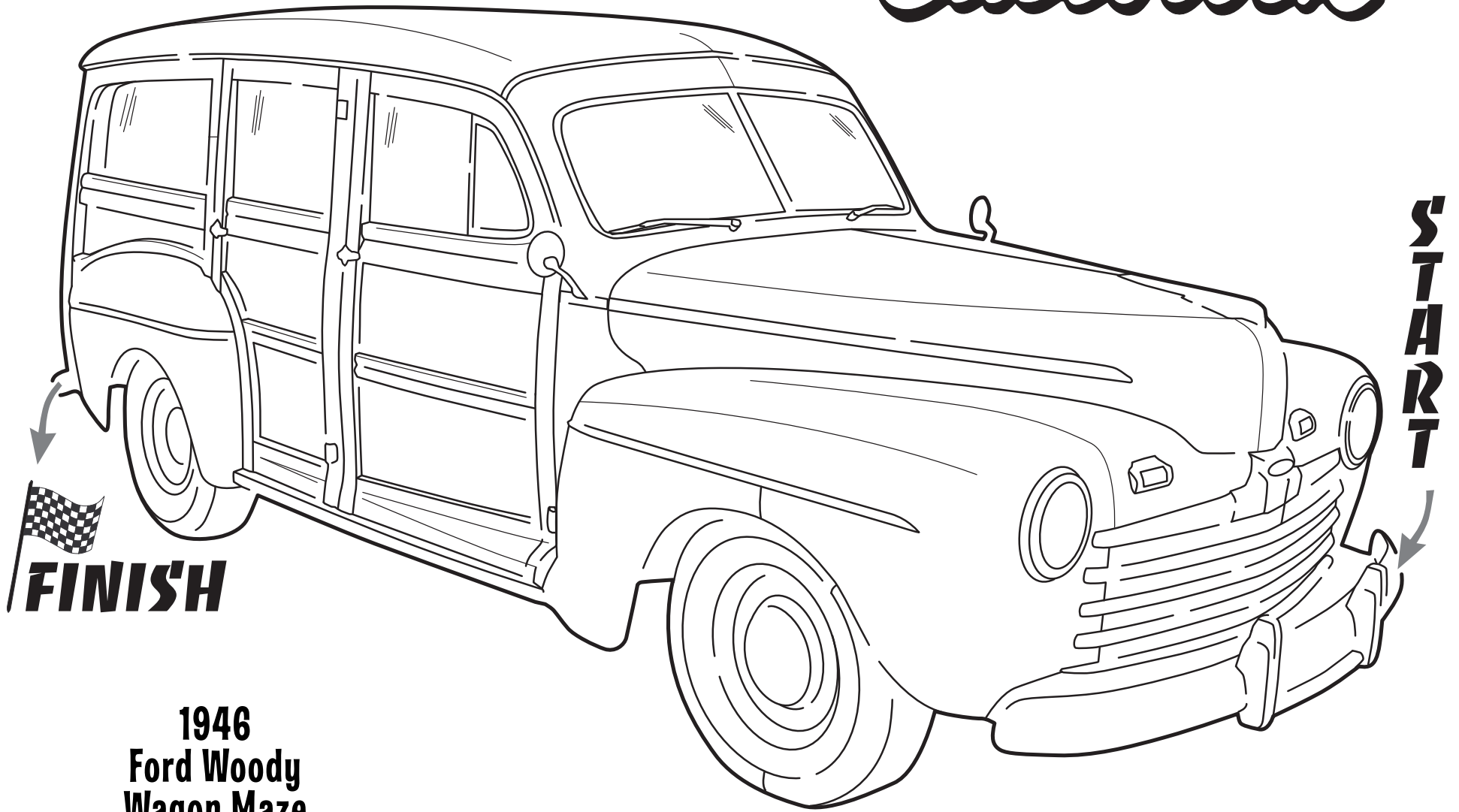

FINISH

**1946
Ford Woody
Wagon Maze**

START

Matching

Timing
Fuel
Shorty
Jeep
Intake
Ford
Power
Circle
Drag
Crate
Gear
Cylinder
Air
Shock
Dodge
Chevrolet
Nitrous
Turbo
Dual
Throttle
Valve
Magneti

Manifold
Absorber
Cleaner
Injection
Charger
Drive
Chain
Head
Cover
Header
Body
Engine
Package
Quad
Plate
Racer
Track
Marelli
Mustang
Camaro
Ram
Cherokee

Unscramble the Letters

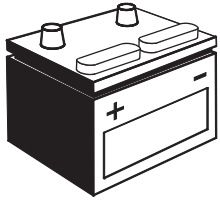

TREBATY

--	--	--	--	--	--	--	--

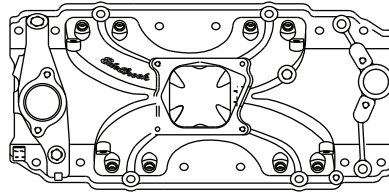

FLONAMID

--	--	--	--	--	--	--	--

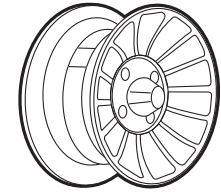

HEWEL

--	--	--	--	--

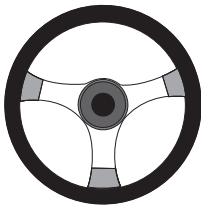

GREENSELITHEW

--	--	--	--	--	--	--	--	--	--	--	--



DAHGELITH

--	--	--	--	--	--	--	--	--	--

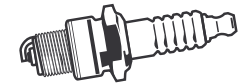

GRAKPULPS

--	--	--	--	--	--	--	--	--	--

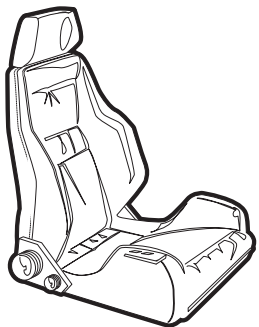

TESA

--	--	--	--



RETI

--	--	--	--



BRASSHOROBECK

--	--	--	--	--	--	--	--	--	--	--	--

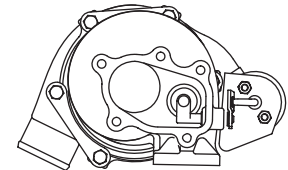

BUROT

--	--	--	--	--

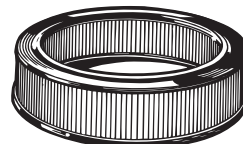

TRAILFIRE

--	--	--	--	--	--	--	--	--	--

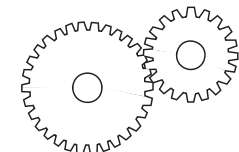

SAGER

--	--	--	--	--

Word Search

EDELBROCK
MANIFOLD
CARBURETOR
MOTORCYCLE
SUPERCHARGER
PERFORMANCE
ENGINE
DRAGRACER
DRAGSTER
SLINGSHOT
HOOD
NITRO
FUN
MIDGET
STRIP
TRACK
TRUCK
PISTON
STREET
VICTOR
GAUGE
PITSTOP
RACECAR
FLAG
TIRE
WHEEL

C	X	F	J	S	U	P	E	R	C	H	A	R	G	E	R	R	Q
B	A	K	T	T	Q	D	L	J	S	Z	T	Q	H	N	V	E	E
Q	D	R	A	G	R	A	C	E	R	B	X	Z	R	G	F	T	D
T	I	F	B	K	J	U	Y	T	O	H	S	G	N	I	L	S	E
P	R	J	N	U	F	S	C	U	Q	A	W	P	K	N	A	G	L
I	P	X	B	I	R	C	R	K	E	X	R	H	L	E	G	A	B
S	I	S	J	U	T	E	O	Z	G	A	U	G	E	C	X	R	R
T	T	W	K	C	A	R	T	B	P	Y	T	I	R	E	M	D	O
O	S	R	Z	G	X	H	O	O	D	K	B	Q	T	J	L	W	C
N	T	T	E	G	D	I	M	J	R	A	C	E	C	A	R	D	K
Q	O	V	P	E	R	F	O	R	M	A	N	C	E	W	Z	J	S
K	P	V	I	C	T	O	R	Q	B	D	L	O	F	I	N	A	M

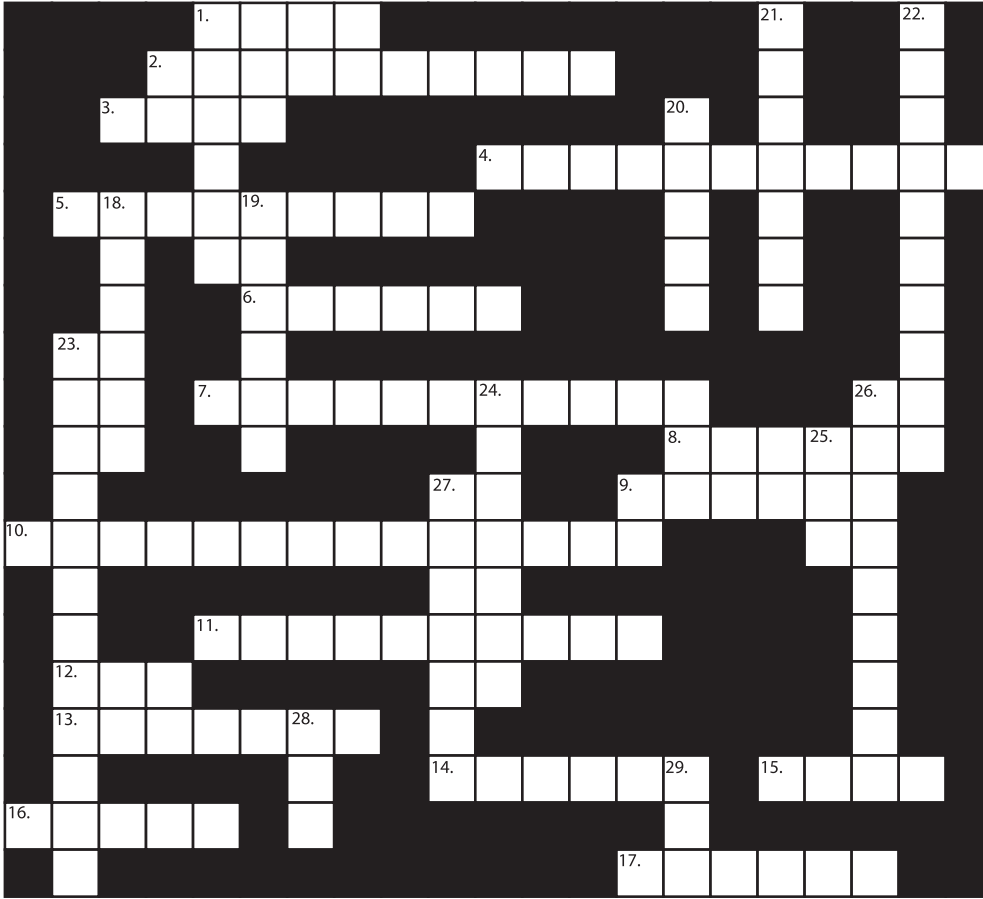

ACROSS

- 1. "The Fun _____"
- 2. Sits on top of the carburetor
- 3. Water _____
- 4. Pre-assembled engine
- 5. The first Edelbrock intake manifold
- 6. Dampens road bumps
- 7. "A passion for _____"
- 8. A small race car
- 9. Abbrev. for National Assoc. of Stock Car Racing
- 10. Directs air/fuel mixture to the cylinders
- 11. Mixes air and fuel
- 12. Revolutions per minute
- 13. A replacement for exhaust manifolds
- 14. Four ____ engine
- 15. Abbrev. for National Hot Road Association
- 16. ____ cover
- 17. Creates compression in the cylinder

DOWN

- 1. _____ gear
- 18. Rides the camshaft
- 19. Flat piece of composite that prevents leaks
- 20. The song, "Little _____ Coupe"
- 21. Place where molten aluminum is poured
- 22. Moves pistons up and down
- 23. Home of valves and combustion chamber
- 24. Quiets the exhaust noise
- 25. The engine burns this
- 26. An Edelbrock intake manifold
- 27. A gas that adds power to your engine
- 28. Hot _____
- 29. Abbrev. for Electronic Fuel Injection

ANSWERS ACROSS

- 1. team
- 2. air cleaner
- 3. pump
- 4. crate engine
- 5. slingshot
- 6. shocks
- 7. performance
- 8. midget

9. NASCAR

- 10. intake manifold
- 11. carburetor
- 12. RPM
- 13. headers
- 14. stroke
- 15. NHRA
- 16. valve
- 17. piston

ANSWERS DOWN

- 1. timing
- 18. lifter
- 19. gasket
- 20. deuce
- 21. foundry
- 22. crankshaft
- 23. cylinder head
- 24. muffler
- 25. gas
- 26. performer
- 27. nitrous
- 28. rod
- 29. EFI

Edelbrock[®]

***CRATE ENGINE
MAZE***

START

